

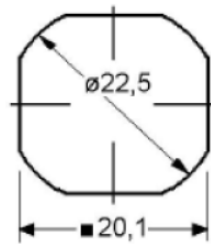

Triangular ley Cam Lock



Outside diameter 28 mm



Diameter 22.5 mm

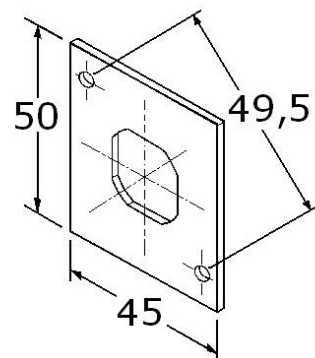

43.295 mounting plate

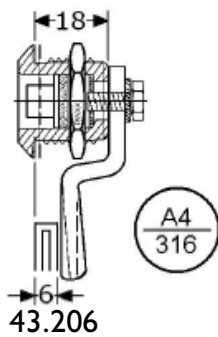

43.206

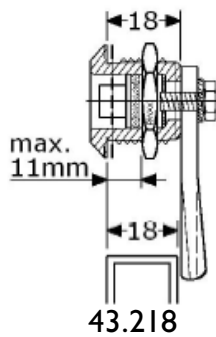

43.218

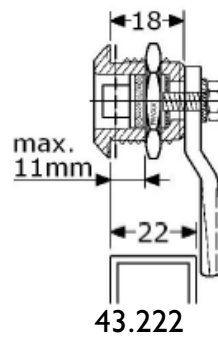

43.222

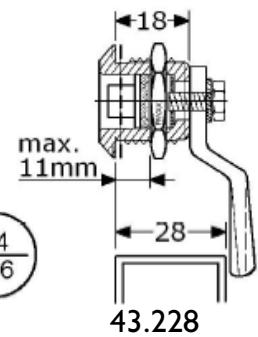

43.228



43.183 Triangular keys



43.180



Mounting plate with holes 43.295

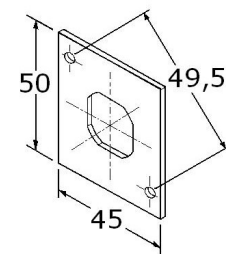



#43.112



-12 mm ~ 1/2"



#43.100



neutral

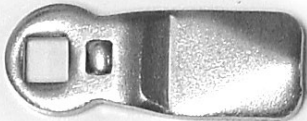

#43.104



+ 4 mm ~ 1/4"



#43.110



+10 mm ~ 3/8"

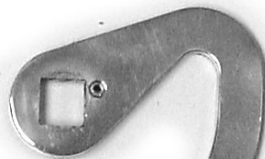

#43.227

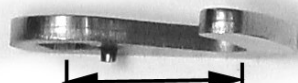

25 mm ~ 1"

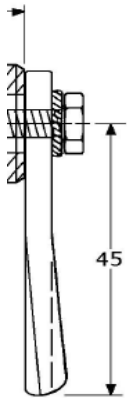

All Cams are 45 mm long measured from center square hole. Square hole 8 x 8 mm Thickness: 4 mm

All sizes are approximate

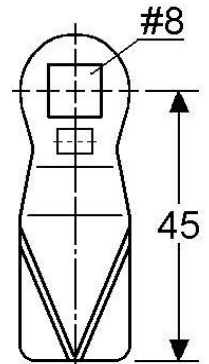

All Cams are 45 mm long measured from center square hole. Square hole 8 x 8 mm Thickness: 4 mm

All sizes are approximate

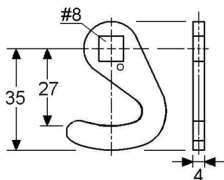

Cams be used with the following Cam Latches:

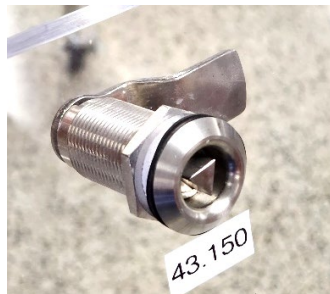
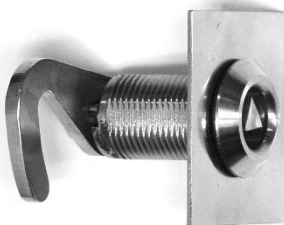

Cam latch #43.150 with hook cam #43.227 & Cam 43.112



Flush Cam Latch #43.5111 with Turn & Lift Ring and #43.104

