

Izerwaren  
Order  
numbers

- Tubular latch sets; steel parts Interior Grade
- Satin stainless steel
- Mirror Polished stainless steel



12.723238  
12.723234

Passage bolt with standard strike  
60 mm backset or 2 3/8 inch  
70 mm backset or 2 3/4 inch  
Sample roses #12.173114



12.724238  
12.724234

Privacy bolt with strike ; pin operated. Sample roses #12.173115  
60 mm backset or 2 3/8 inch  
70 mm backset or 2 3/4 inch

1 1/8" (28.5 mm) Faceplate optional.

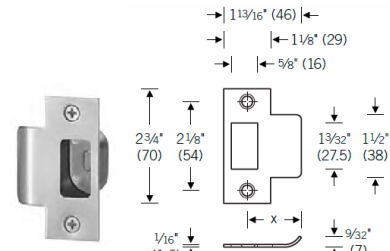
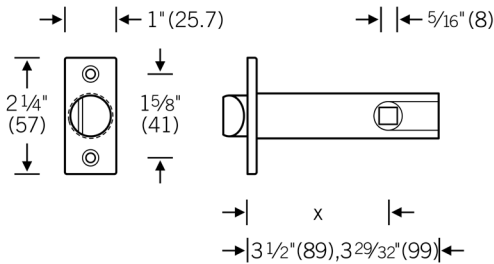

Strike plate #12.1001 stainless steel

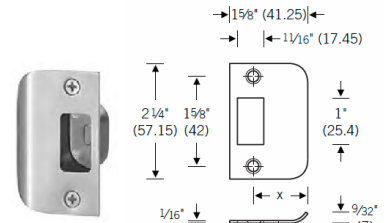

Strike plat #12.1003 stainless steel



Privacy bolt #12.725238 & Thumb-turn set #12.1704  
Passage latch #12.723238  
With rose pair #12.1703 and Lever pair #12.1251  
Satin Stainless Steel Finish

12.725238

Dead Bolt 2 3/8" backset with strike box; #12.1704 Privacy set  
square roses

12.725234

Dead Bolt 2 3/4" backset with strike box



12.725238

Dead bolt 2 3/8 backset with strike box; #12.1735 Privacy set  
round roses

12.725234

Dead Bolt 2 3/4 inch backset with strike bolt  
60 mm backset or 2 3/8 inch  
70 mm backset or 2 3/4 inch

Function R = one sided - thumb turn only - please specify  
Function S = both sided thumb turn indicator - please specify



#13.3295RS thumb-turn only with square rose  
#13.3296RS indicator only with square rose



#13.3293RF thumb-turn only with round rose  
#13.3294RF indicator only with round rose



Privacy bolt #12.725238 & Thumb-turn set #12.1735  
Lever #12.1183; Rose #12.173114  
Satin Chrome finish



#12.42311 dummy bolt with blank faceplate;  
for bore hole 3/4 inch hole and 8x8 mm spindle  
One side mounting possible  
Both sides mounting possible

05 0423 00110

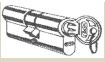

Izerwaren  
Order  
numbers

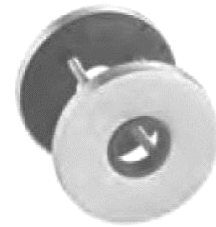

Passage bolt with standard strike  
12.723238 60 mm or 2 3/8 inch backset  
12.723234 70 mm or 2 3/4 inch backset

Roses #12.173114

1 1/8" (28.5 mm) Faceplate optional.

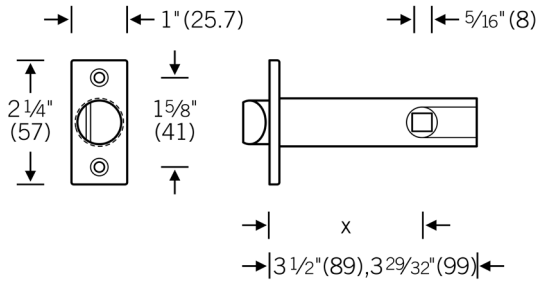

Tubular passage and privacy latch 2 3/8 inch and 2 3/4 inch backset



Privacy bolt with strike ; pin operated.  
12.724238 60 mm backset or 2 3/8 inch  
12.724234 70 mm backset or 2 3/4 inch

Roses #12.173115



12.725238 Privacy Dead Bolt; 2 3/8" backset  
12.725234 Privacy Dead Bolt; 2 3/4" backset #12.1735.508 set square roses #12.239.508 set round roses  
with strike box; Roses 55 x 55 mm or 65 x 65 mm see page 1-2-2

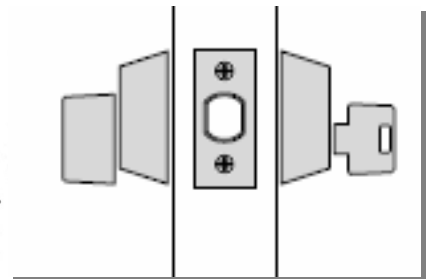
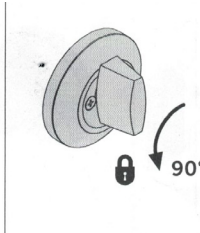
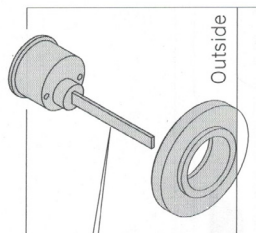

12.238134 #12.23834 Dead Bolt 2 3/4" backset with strike box for key/key or key/ thumb-turn  
12.238138 #12.23838 Dead bolt 2 3/8" backset with strike box; for key/key or key/ thumb-turn

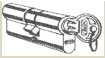

**DUMMY SETS**



#12.4231 | dummy SET with separate face plate (not shown) roses and lever #12.045



#12.42315 DUMMY SET WITH SQUARE OR ROUND 65 MM ROSES, LEVERS  
#12.42313 DUMMY SET WITH SQUARE OR ROUND 55 MM ROSES, LEVERS

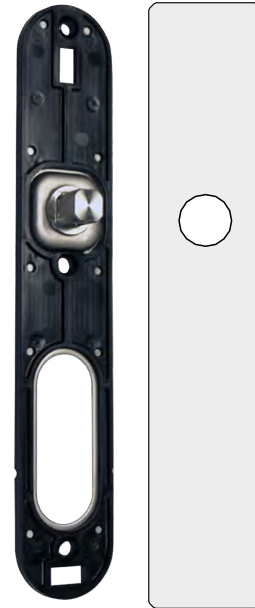

#12.42314 SET: DUMMY WITH ESCUTCHEON #12.1410 245X45 MM

**KEYWAY/THUMBTURN SET**

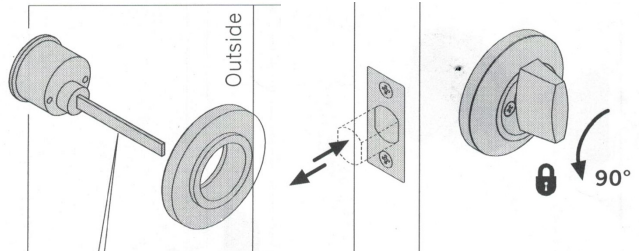
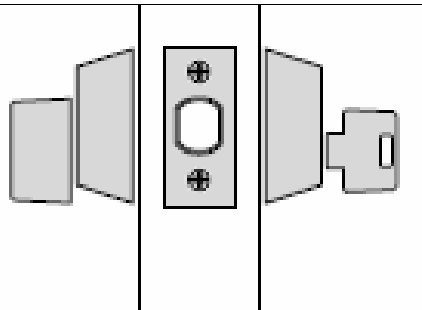

DEADBOLT WITH SCHLAGE KEYWAY #12.238134 BACKSET 2 3/8" FUNCTION KEY/ KNOB

**ROSES FOR KEYWAY**

**DA**

03 0450 09011 ■■  
2 3/16" (55 mm) x 3/4" (19 mm)

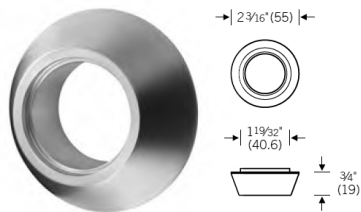

17 1704 12601 ■■

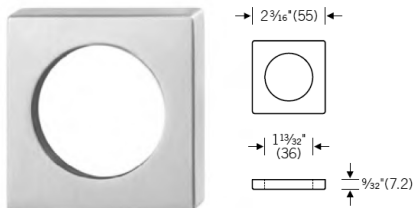

**DD**

03 0450 09010 ■■  
2 3/16" (65 mm) x 3/4" (19 mm)

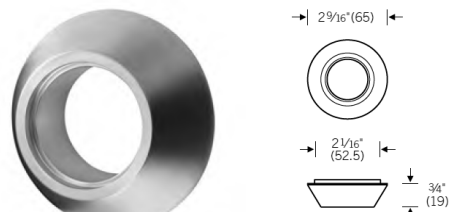

03 0450 09013 ■■  
1 3/8" (35 mm) x 3/16" (5 mm)

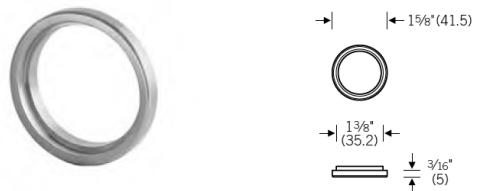

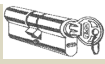

Izerwaren  
Order  
numbers

- Stainless Steel Roses for marine locks
- Specify Finish:
- Satin stainless steel or
- Mirror Polished stainless steel

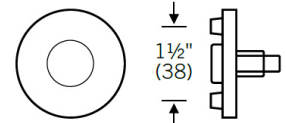

Stainless steel rose round,  
55 mm or 2 3/16 inch diameter  
Clip on style with inner rose  
Screws invisible

12.173114 **Stainless steel rose,**  
55 mm diameter or 2 3/16 inch  
Clip on style with inner rose  
For Levers. Screws invisible



#12.173114 Round Rose flat  
55 mm diameter

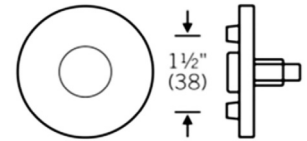
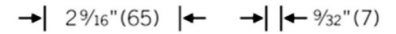

Stainless steel rose round,  
55 mm or 2 9/16 inch diameter  
Clip on style with inner rose  
Screws invisible

12.179814 **Stainless steel rose, pair**  
65 mm diameter or 2 9/16 inch  
Clip on style with inner rose  
For Levers. Screws invisible



#12.179814 Round Rose flat  
65 mm diameter

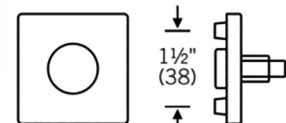

Stainless steel rose square, pair  
55 x 55 mm or 2 9/16 inch  
Clip on style with inner rose  
Screws invisible

12.1703.508 **Stainless steel rose square,**  
55 x 55 mm or 2 3/16 inch  
Clip on style with inner rose  
For Levers. Screws invisible



#12.1703.508 Square rose flat  
55 x 55 mm

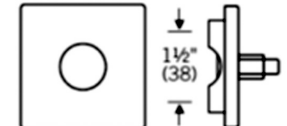
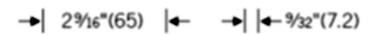

Stainless steel rose square, pair  
65 x 65 mm or 2 9/16 inch  
Clip on style with inner rose  
Screws invisible

12.1705 **Stainless steel rose square,**  
65 x 65 mm or 2 9/16 inch  
Clip on style with inner rose  
For Levers. Screws invisible



#12.1705 Square rose flat  
65 x 65 mm

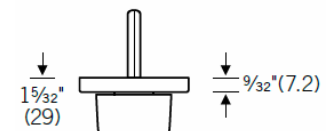

Privacy thumb-turn and indicator  
With round roses 55 mm diam.

12.1735.508 **Stainless steel Privacy set,**  
Thumb-turn with indicator with  
55 mm or 2 3/16 inch diameter roses  
Clip on style with inner rose  
Screws invisible  
12 1735 10054



#12.1735.508 Privacy set  
Thumb-turn + indicator  
With round roses flat 55 mm

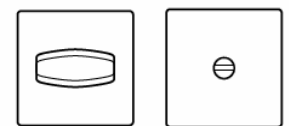
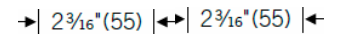

Privacy set  
With square roses flat 55 x 55 mm

12.1736.508 **Stainless steel Privacy set,**  
Thumb-turn with indicator with  
55 x 55 mm or 2 3/16 x 2 3/16 inch  
square roses; Clip on style with inner  
rose  
Screws invisible  
12 1704 0054



#12.1736.508 Privacy set  
Thumb-turn + indicator  
With square roses flat 55 x 55 mm

12.1704.508 **Stainless steel Key rose,**  
55 x 55 mm or 2 3/16 x 2 3/16 inch  
square roses for profile cylinder;  
Clip on style with inner rose  
Screws invisible  
17 1703 00210



#12.1704.508 Key rose square flat  
55 x 55 mm

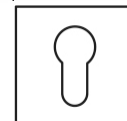
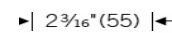

Key rose square flat  
55 x 55 mm



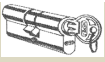

Izerwaren  
Order  
numbers

- Stainless Steel Roses for marine locks
- Specify Finish:
- Satin stainless steel or
- Mirror Polished stainless steel



Privacy Latch  
#12.725234 2 3/4 inch backset  
#12.725238 2 3/8 inch backset

12.173115 **Stainless steel rose, Privacy set**  
55 mm diameter or 2 3/16 inch  
Clip on style with inner rose  
For Tubular latch & Levers  
Screws invisible



#12.173115 Rose for tubular privacy set  
55 mm diameter

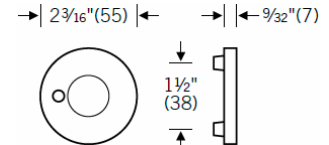

#12.173115 Rose for tubular privacy latch  
55 mm diameter

12.179815 **Stainless steel rose, Privacy set**  
65 mm diameter or 2 9/16 inch  
Clip on style with inner rose  
For Tubular latch & Levers  
Screws invisible



#12.179815 Rose for tubular latch  
65 mm diameter

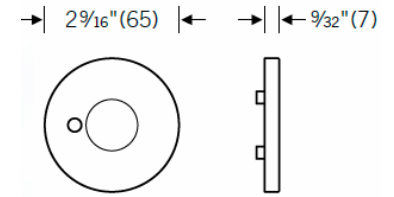

#12.179815 Rose for tubular privacy latch  
65 mm diameter

12.170315 **Square Rose for Privacy latch,**  
55 x 55 mm or 2 3/16 inch  
Clip on style with inner rose  
For Tubular latch and Levers  
Screws invisible



#12.170315 Square rose for tubular privacy latch; 55 x 55 mm

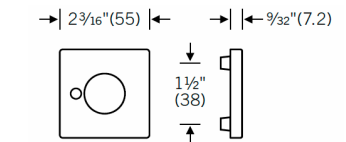

#12.170315 Square rose for tubular privacy latch; 55 x 55 mm

12.170515 **Square rose for privacy set,**  
Thumb-turn with indicator with  
55 mm or 2 3/16 inch diameter roses  
Clip on style with inner rose  
Screws invisible



#12.170515 Square rose for privacy latch; 65 x 65 mm

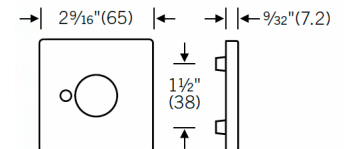

#12.170515 Square rose for tubular latch  
65 x 65 mm

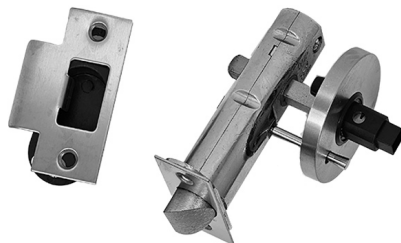

Privacy latch -  
Showing options with 55 mm diameter Roses

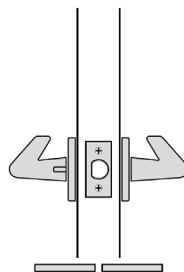

**Description**

Latch bolt by handle either side. Outside handle locked by push button inside. Outside handle unlocked by retracting inside handle, emergency release tool, or closing the door.





DECORATIVE AND FUNCTIONAL STAINLESS STEEL TRIM  
FOR MARINE AND COMMERCIAL APPLICATIONS  
**FROM [WWW.IZERWAREN.COM](http://WWW.IZERWAREN.COM)**

[SALES@IZERWAREN.COM](mailto:SALES@IZERWAREN.COM) PHONE: 954-763-6686 FAX: 954-522.6903





EXPLODED VIEW 2019 SETUP STAINLESS STEEL LEVERS AND STAINLESS STEEL ROSES

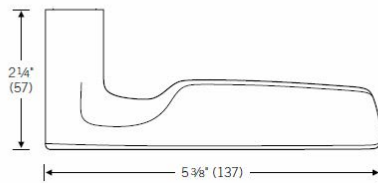

Lever shown:

LEVER 12.1093

ROSE 12.110N

[WWW.IZERWAREN.COM](http://WWW.IZERWAREN.COM)

[SALES@IZERWAREN.COM](mailto:SALES@IZERWAREN.COM)

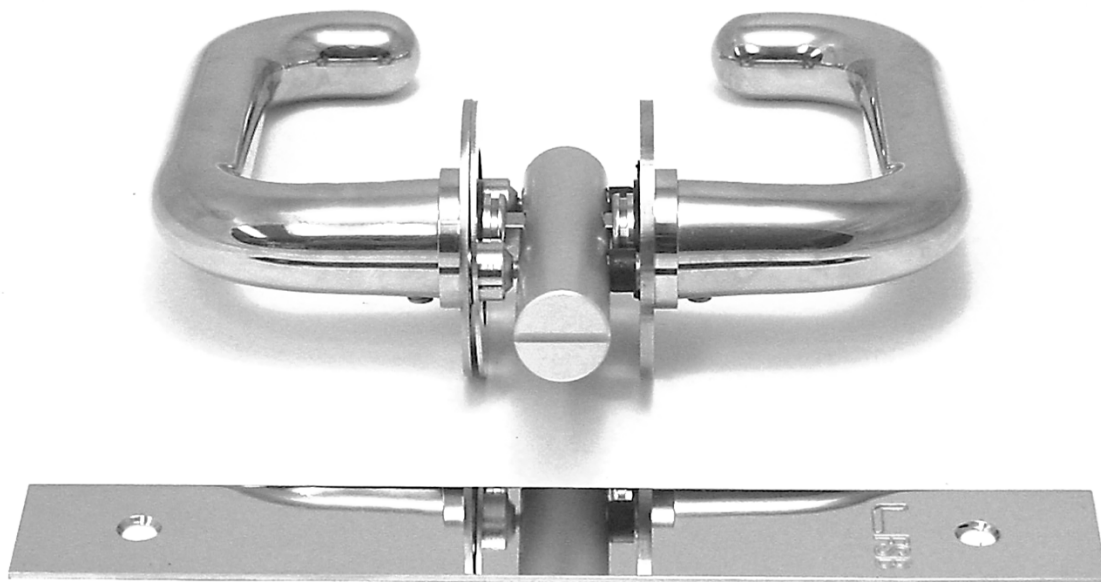

Part no. 12.42311; **Dummy set complete** as shown, with face plate, lever 12.045 and special roses.

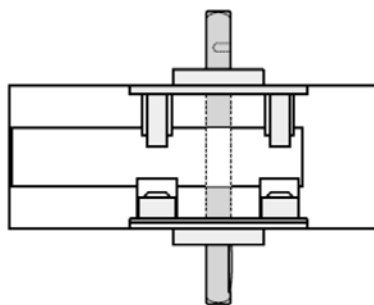

Through bolted mounting  
with  $\frac{3}{4}$ "  $\varnothing$  borehole.

Set includes one mount bar, one straight  
spindle, one pair of  $2\frac{3}{16}$ " (55 mm) flush  
roses and two levers. Supplied with blank  
faceplate to cover edge borehole.



In the early 1990s we gave the plain round rod of the stable-door handle a going over. The shank was conically widened and a hemispherical tip was added to the bent end. Two small but important special features that have given the 1146 model a character all of its own.



**LEVER: 12.045      ROSE: 12.110**

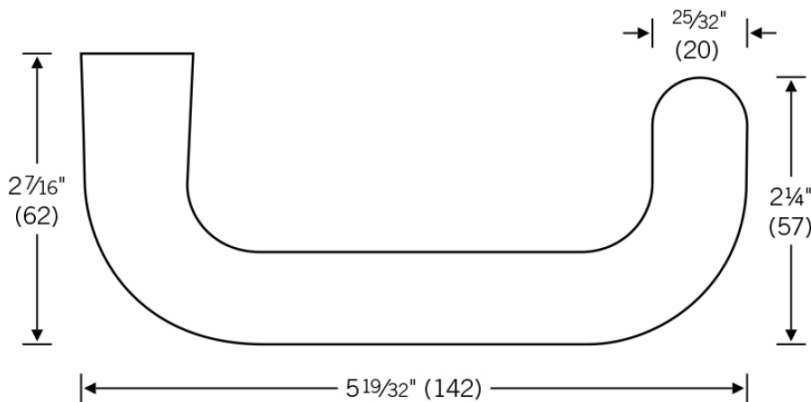

**PULL: 12.666662**



**ENTRY MORTISE LOCK COMMERCIAL GRADE**

**WITH STAINLESS STEEL LEVERS, THUMB-TURN AND SCHLAGE KEYWAY**

**LEVER: 12.1035 ROSE: 12.110 MECHANISM: UL RATED COMMERCIAL GRADE**

**[WWW.IZERWAREN.COM](http://WWW.IZERWAREN.COM) [SALES@IZERWAREN.COM](mailto:SALES@IZERWAREN.COM)**

In the autumn of 1996, Düsseldorf-based interior designer Heike Falkenberg asked to recreate an old handle design for a renovation job. Using the sketch she submitted, developers milled a prototype from an 1076 handle. This looked so good that we decided to market our gripping idea.



**LEVER: 12.1035**

**ROSE: 12.1703**

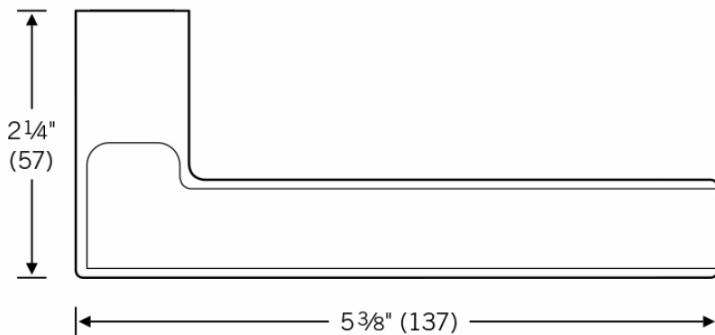

**DOOR PULL: 12.666540**



Interior Grade Privacy Set Up with Tubular Bolts and Lever #12.1251 and Rose #12.1703  
Thumb-turn set with square roses #12.1736



**LEVER: 12.1251**

**ROSE: 12.110**

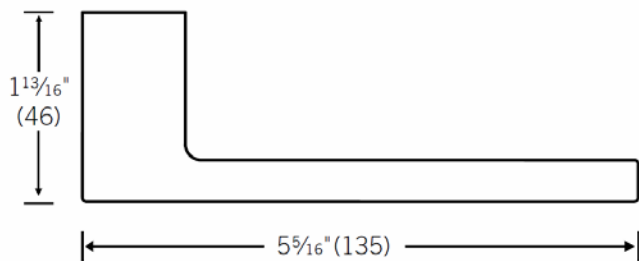

**WWW.IZERWAREN.COM SALES@IZERWAREN.COM**