

SLAM LATCH WITH PUSH/PULL MECHANISM WITH 1 INCH BACKSET FOR 3/4 INCH THICK DOORS

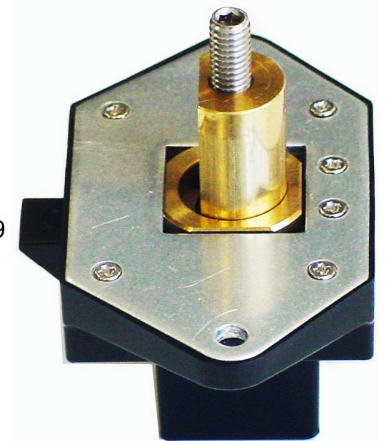
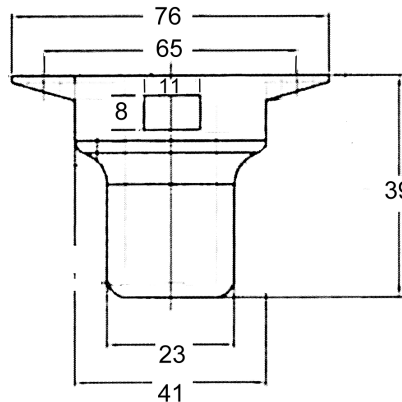
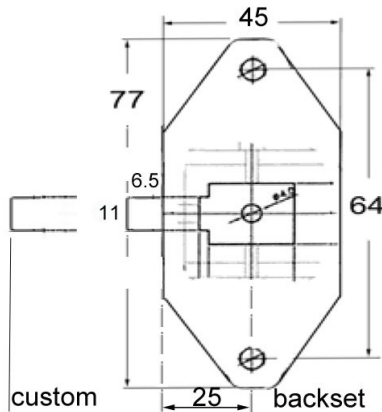

#25.5275 SET with S / S push button set; 25 mm backset
Drill hole 25 mm diameter for ring

#25.525
Standard Mechanism
Backset 25 mm

HOW TO OPERATE:

<p>① Close drawer or door <i>(slam latch action; hands free action)</i></p>	<p>② Push to have button retracted</p>	<p>③ Push to have button pop out</p>	<p>④ Pull Button To open drawer or door <i>(latch retracts)</i></p>



Front view "Pulled" extended
Latch bolt retracted, door opens

Position: ④

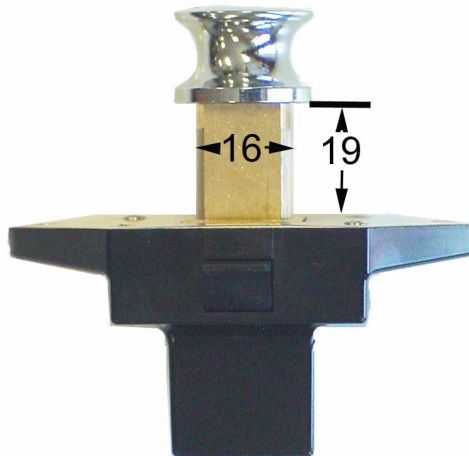

Front view extended
Button extended, door locks

Position: ③







Side view compressed
Button flush compressed, door locks

Position: ②

Door Thickness can vary from 5/8" to 1 1/4" or more by use from fillerplates and spacers

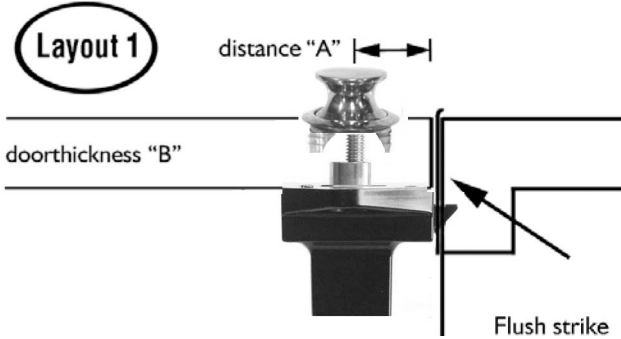
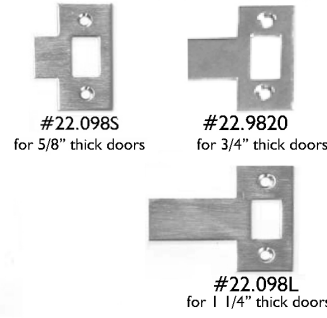
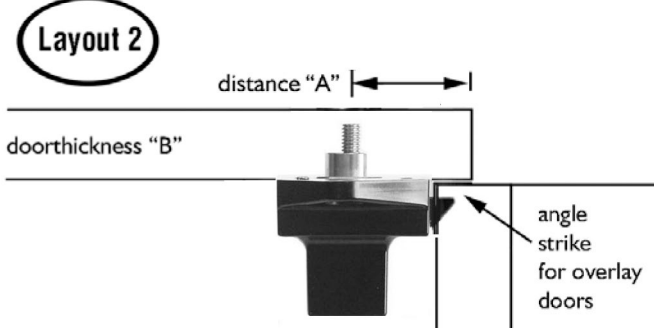
Backset can vary from 3/4" to 3" or more by extending the latchbolt. Specify when order.

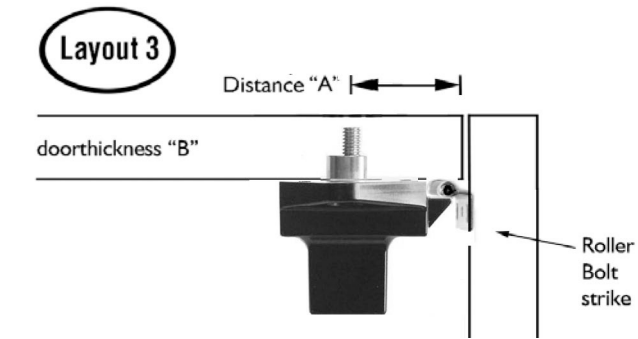
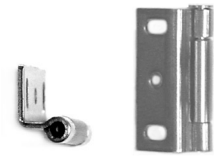
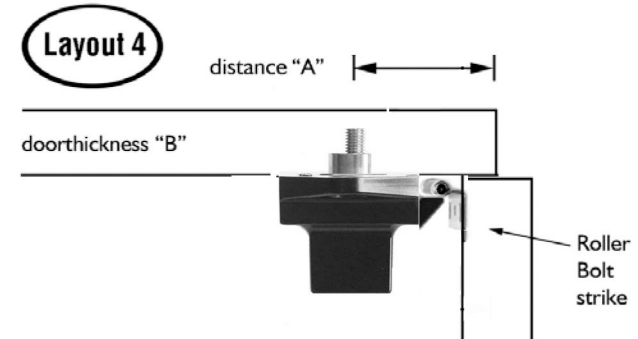

Backset 25 mm (1 inch)			BACKSET MECHANISM IN RELATION TO DOOR LAY OUT
CENTER HOLE FOR RING FROM EDGE OF DOOR AT: (DISTANCE "A")			DOOR THICKNESS (= B) SUITABLE FOR 3/4" INCH DOOR, OR 5/8" INCH OR 1" DOORS - OR - SPECIFY CUSTOM DOOR THICKNESS UPTO 1 1/2" THICK.
25 mm (1 inch) Part no. 25.525			<p>Layout 1</p>  <p>Set up with flush door and flush strike</p>  <p>#22.098S for 5/8" thick doors #22.9820 for 3/4" thick doors #22.098L for 1 1/4" thick doors</p>
31 mm (1 1/4 inch) Part no. 25.525			<p>Layout 2</p>  <p>Set up with overlay doors with angle strike for overlay doors</p>  <p>Angle Strike #23.097</p>
35 mm (1 3/8 inch) Part no. 25.525			<p>Layout 3</p>  <p>Setup with flush doors and roller bolt strike</p>  <p>Roller Bolt Strike #23.099</p>
41 mm (1 5/8 inch) Part no. 25.525			<p>Layout 4</p>  <p>Set up with overlay doors and roller bolt strike 1/4" filler plate required Strike #23.099</p>  <p>Roller Bolt Strike</p>



"A SET MAKES THE INSTALLATION A SUCCESS"

SET CONSIST OF THE FOLLOWING PARTS:

ORDER SETS:

With polished stainless steel button & ring

25.5275: 25 mm backset mechanism with installation kit

Parts separate:

- 25.525: 25 mm backset mechanism only
- 22.9820: strike plate with lip 20 mm; polished chrome
- 23.097: strike plate bend, satin stainless steel
- 23.099: Roller bolt strike, satin stainless steel
- 24.552: button stainless steel 316 mirror polished
- 24.553: ring stainless steel 316 mirror polished
- 24.559: spacer for button 6 mm
- 24.569: spacer for button 1 mm
- 24.557: Filler plate for body

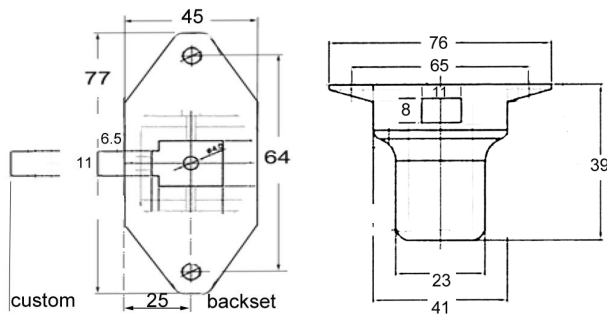

Dimensions mechanism in mm.

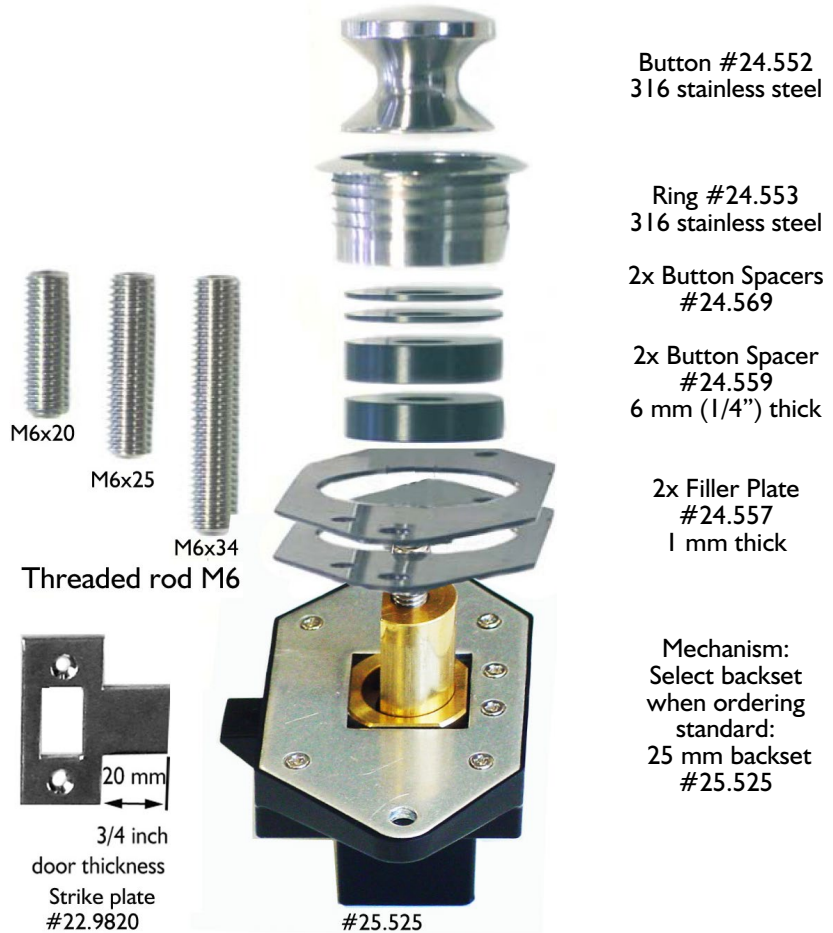

**SPECIFY BACKSET MECHANISM
STANDARD BACKSET: 25 MM OR 1 INCH.**

Strike plate for 3/4 inch doors

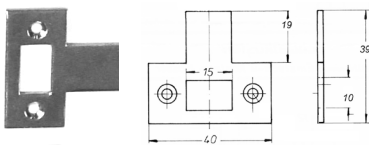

- 22.9820 #22.9820 strike for 3/4 inch thick doors
- 22.098S #22.098S strike for 5/8 inch doors
- 22.098L #22.098L strike for 1 1/4 inch doors

Strike for overlay doors (separate)
Stainless steel 60 x 18 x 8 mm

(order separate)

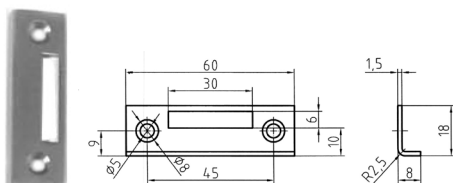

- 23.097 #23.097 strike plate stainless steel.
For use with overlay doors applications

STAINLESS STEEL BUTTON AND RING INCLUDED IN SET:



Drill hole 26 mm diameter for ring

(order separate)



Strike #23.099 Roller bolt strike
30 x 10 mm

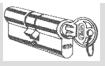

SET CONSIST OF THE FOLLOWING PARTS:

ORDER SETS:

With Polished Chrome Brass button & ring

25.7254. 25 mm backset mechanism with installation kit

Parts separate:

- 24.525: 25 mm backset mechanism only
- 24.9820: strike plate with lip; polished chrome
- 23.097: strike plate bend, stainless steel
- 23.099 Roller bolt strike
- 24.125.266: button brass polished chrome
- 24.135.266: ring brass polished
- 24.559: spacer for button 6 mm
- 24.569: spacer for button 1 mm
- 24.557: filler plate for body 1 mm



- Button #23.125
Chrome plated brass
- Ring #23.135
Brass
- 2x Button Spacers
#24.569
- 2x Button Spacer
#24.559
6 mm (1/4") thick
- 2x Filler Plate #24.557
1 mm thick
- Mechanism:
#25.525
Standard:
25 mm backset.



Strike plate for 3/4 inch doors

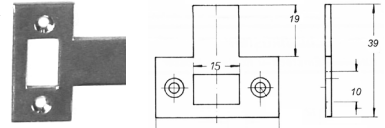

- 22.9820 #22.9820 strike for 3/4 inch thick doors
- 22.098S #22.098S strike for 5/8 inch doors
- 22.098L #22.098L strike for 1 1/4 inch doors

Strike for overlay doors (order separate)
Stainless steel 60 x 18 x 8 mm

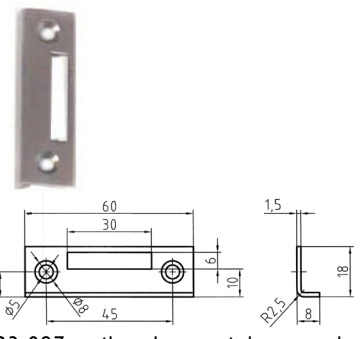

- 23.097 #23.097 strike plate stainless steel. For use with overlay doors applications. Please order separate (order separate)
- 23.099

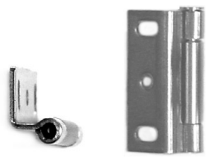

Strike #23.099 30 x 10 mm

SPECIFY BACKSET MECHANISM
STANDARD BACKSET: 25 MM OR 1 INCH.

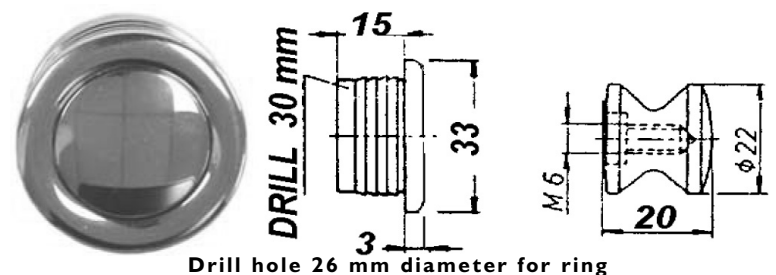
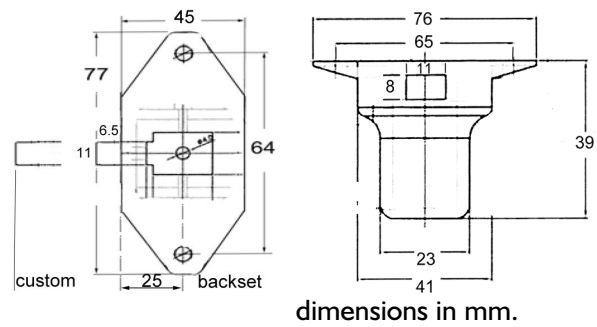

Drill hole 26 mm diameter for ring

This set allows for installation for any door thickness from 1 1/16 To 1 1/4 inch thick doors, by simply applying the filler plates, button spacers and threaded rods in any desired combination. Angle strike #23.012 is included with the set. Specify other strikes as needed. Separate buttons, rings, parts list of page and page

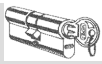

SET CONSIST OF THE FOLLOWING PARTS:

ORDER SETS:

With Polished Chrome Brass button & ring

25.6253: 25 mm backset mechanism with installation kit

Parts separate:

- 24.525: 25 mm backset mechanism only
- 24.9820: strike plate with lip; polished chrome
- 23.097: strike plate bend, stainless steel
- 23.099: Roller bolt strike
- 24.125.266: button brass polished chrome
- 24.135.266: ring brass polished
- 24.559: spacer for button 6 mm
- 24.569: spacer for button 1 mm
- 24.557: filler plate for body 1 mm



Button #23.125
Chrome plated brass

Ring #23.135
Brass

2x Button Spacers #24.569

2x Button Spacer #24.559
6 mm (1/4") thick

2x Filler Plate #24.557
1 mm thick

Mechanism: #25.525
Standard: 25 mm backset.

Strike plate for 3/4 inch doors

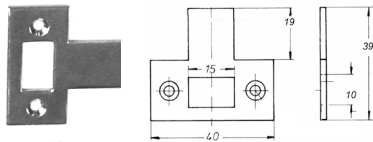

- 22.9820 #22.9820 strike for 3/4 inch thick doors
- 22.098S #22.098S strike for 5/8 inch doors
- 22.098L #22.098L strike for 1 1/4 inch doors

Strike for overlay doors (order separate)
Stainless steel 60 x 18 x 8 mm



23.097

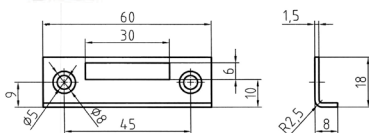

#23.097 strike plate stainless steel. For use with overlay doors applications. Please order separate

23.099

(order separate)

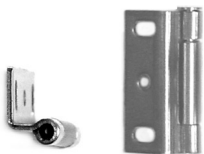

Strike #23.099 30 x 10 mm

SPECIFY BACKSET MECHANISM STANDARD BACKSET: 25 MM OR 1 INCH.

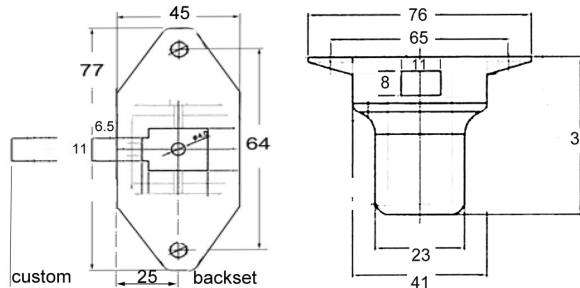

dimensions in mm.

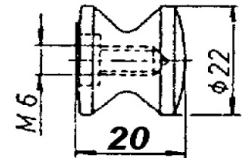
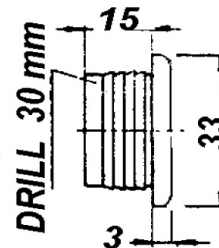

Drill hole 26 mm diameter for ring

This set allows for installation for any door thickness from 11/16 To 1 1/4 inch thick doors, by simply applying the filler plates, button spacers and threaded rods in any desired combination. Angle strike #23.012 is included with the set. Specify other strikes as needed. Separate buttons, rings, parts list of page and page

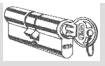

SET CONSIST OF THE FOLLOWING PARTS:

ORDER SETS:

With Satin Nickel Plated Brass Button & Ring

25.8799: 25 mm backset mechanism with installation kit

Parts separate:

- 25.525: 25 mm backset mechanism only
- 24.9820: strike plate with lip; polished chrome
- 23.097: strike plate bend, stainless steel
- 23.099: Roller bolt strike
- 24.811.556: button satin nickel plated
- 24.821.556: ring satin nickel brass
- 24.559: spacer for button 6 mm
- 24.569: spacer for button 1 mm
- 24.557: filler plate for body 1 mm

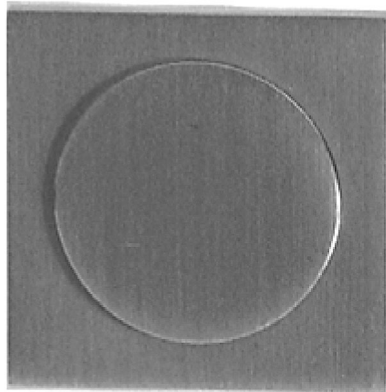

Strike plate for 3/4 inch doors

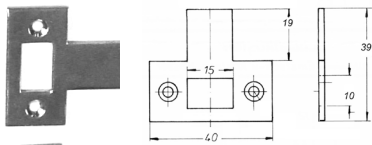

- 22.9820 #22.9820 strike for 3/4 inch thick doors
- 22.098S #22.098S strike for 5/8 inch doors
- 22.098L #22.098L strike for 1 1/4 inch doors

Strike for overlay doors (order separate)
Stainless steel 60 x 18 x 8 mm

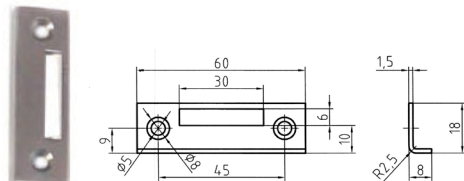

#23.097 strike plate stainless steel.
For use with overlay doors applications
Please order separate
(order separate)

23.097

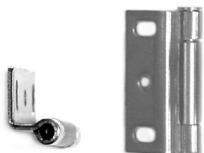

23.099

Strike #23.099 30 x 10 mm



Button #24.811
Satin Nickel

Ring #24.821
Satin Nickel

2x Button Spacers
#24.569

2x Button Spacer
#24.559
6 mm (1/4") thick

2x Filler Plate #24.557
1 mm thick

Mechanism:
#25.525
Standard:
25 mm backset.



**SPECIFY BACKSET MECHANISM
STANDARD BACKSET: 25 MM OR 1 INCH.**

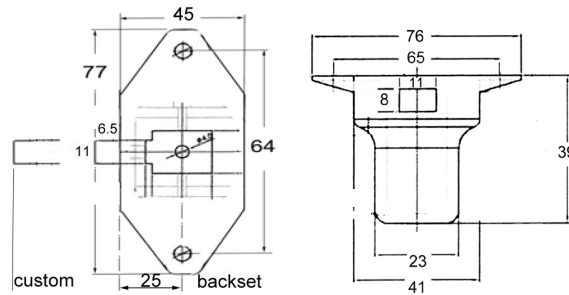

15 mm- 5/8 inch

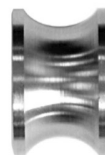

· 38 x 38 mm
1 1/2" x 1 1/2"

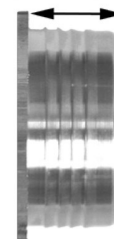

32.5 mm
1 5/16"

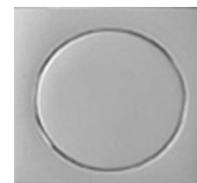

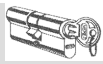

ORDER SETS:

With Satin Nickel Plated Brass Button & Ring

25.8479: 25 mm backset mechanism with installation kit

Parts separate:

- 24.525: 25 mm backset mechanism only
- 24.9820: strike plate with lip; polished chrome
- 23.097: strike plate bend, stainless steel
- 23.099: Roller bolt strike
- 24.811.556: button satin nickel plated
- 24.821.556: ring satin nickel brass
- 24.559: spacer for button 6 mm
- 24.569: spacer for button 1 mm
- 24.557: filler plate for body 1 mm

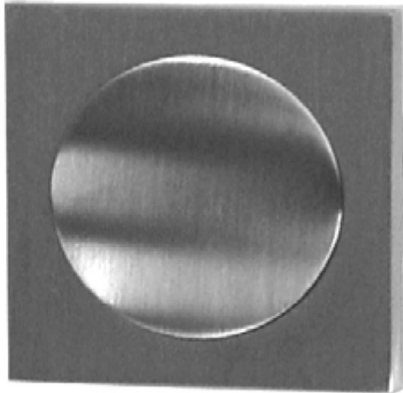

Strike plate for 3/4 inch doors

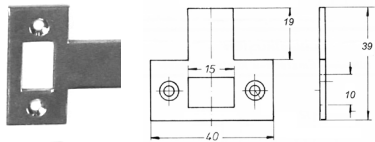

- 22.9820 #22.9820 strike for 3/4 inch thick doors
- 22.098S #22.098S strike for 5/8 inch doors
- 22.098L #22.098L strike for 1 1/4 inch doors

Strike for overlay doors (order separate)

Stainless steel 60 x 18 x 8 mm

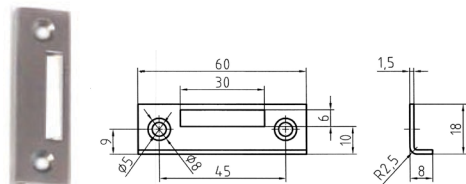

- 23.097 #23.097 strike plate stainless steel. For use with overlay doors applications. Please order separate (order separate)



23.099

Strike #23.099 30 x 10 mm

SET CONSIST OF THE FOLLOWING PARTS:



Button #24.811 Satin Nickel

Ring #24.821 Satin Nickel

2x Button Spacers #24.569

2x Button Spacer #24.559 6 mm (1/4") thick

2x Filler Plate #24.557 1 mm thick

Mechanism: #25.525 Standard: 25 mm backset.

SPECIFY BACKSET MECHANISM STANDARD BACKSET: 25 MM OR 1 INCH.

