

EXTERIOR SETS WITH DIMENSIONS

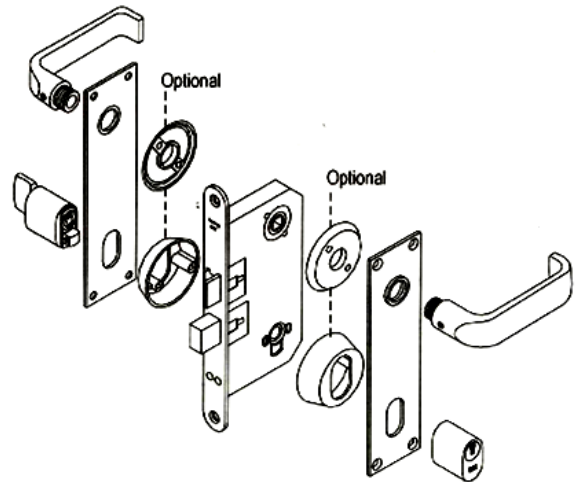

- #11.BEET02 . Complete Entry / Set for exterior doors with polished chrome trim with escutcheons and spacer plate
- #11.BERT01. Complete Entry Set for exterior doors with satin chrome trim and roses.
- #11.BERT02. Complete Entry Set for exterior doors with chrome trim and escutcheon plates.

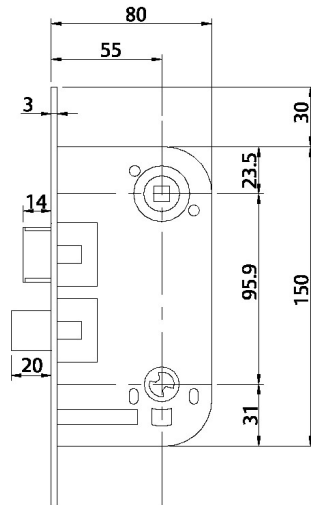
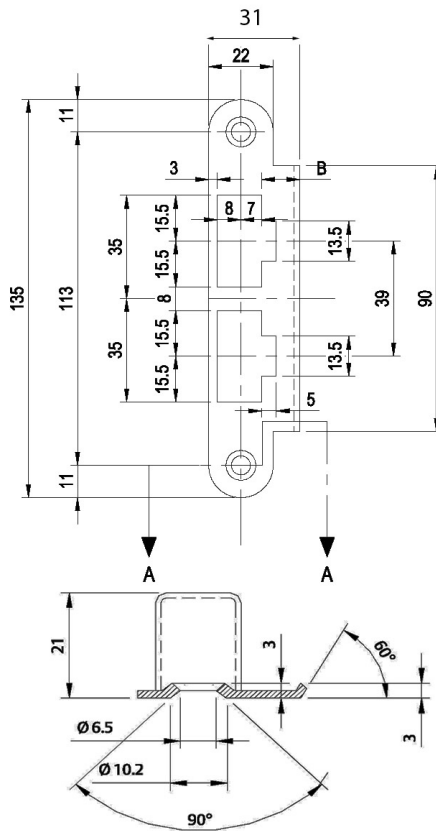
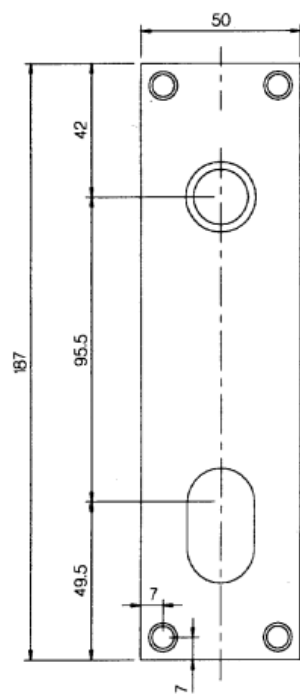
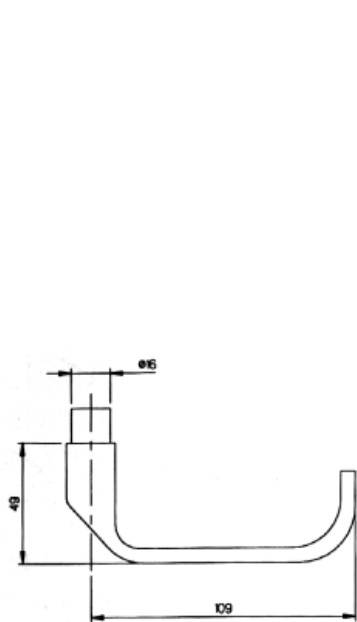

with 2 keys and 1 thumb-turn



(Optional: 2 keyways, no thumb-turn)

- All sets include: 1 keyway
- Specify door thickness when ordering.
- Specify satin or polished
- Specify left or right

UPGRADE TO MEGA YACHT TRIM: #11.SEFT.011.

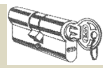

IZERWAREN
Order
numbers

- Trioving Standard Trim for Mortise Locks
- For Trioving locks see page I-1
- For UPGRADE to YACHT trim see page I-2

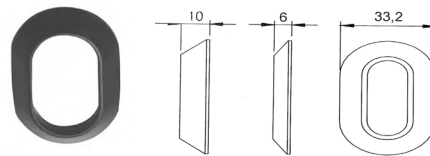

Cylinder coat 11.5967 10 mm thick. 33.2 mm wide. pair
 Cylinder coat 11.5968 6 mm thick. 33.2 mm wide. pair
 Use with escutcheon plates only.

- 11.5967 **Cylinder coat; black plastic, 10 mm.**
- 11.5968 **Cylinder coat; black plastic, 6 mm.**
Use with escutcheon plates only.

Chrome roses for key way Diameter 54 mm:

- 11.962 6 mm thick outer rose with bushings
- 11.9622 9 mm thick outer rose with bushings
- 11.9623 12 mm thick outer rose with bushings
- 11.9624 15 mm thick outer rose with bushings
- 11.9625 18 mm thick outer rose with bushings

- 11.972 6 mm thick inner rose with screw holes
- 11.9722 9 mm thick inner rose with screw holes
- 11.9723 12 mm thick inner rose with screw holes
- 11.9724 15 mm thick inner rose with screw holes
- 11.9725 18 mm thick inner rose with screw holes

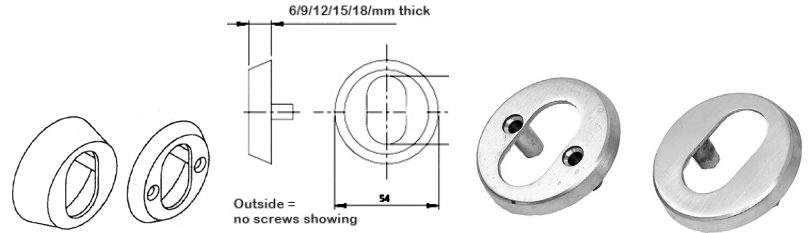

Key way rose outside, and inside. Order separate. 54 mm diameter.
 Specify and order inside and outside thickness of key rose separate.

- 11.520 **Oval Cylinder (half) with key. Body: 32 mm**

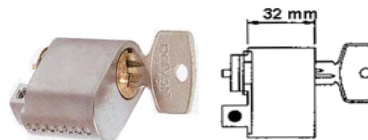

Oval Cylinder key way #11.520 -32 mm

- 11.555 **Extensions** for cylinder or thumb-turn 15 mm, brass

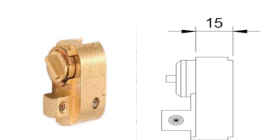

Extensions 15 mm #11.555

- 11.544 **Oval Cylinder (half) with knob. Body:-32 mm**

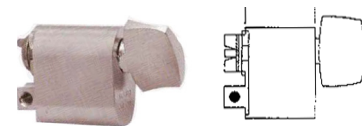

Keyed Thumb-turn #11.544 -32 mm

- 11.555 **Extensions** for cylinder or thumb-turn 15 mm,

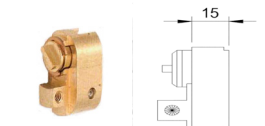

Extensions 15 mm #11.555

- 11.5551 **Extensions** for cylinder or thumb-turn 30 mm,



- 11.5552 **Extensions** for cylinder or thumb-turn 40 mm,



- 11.5553 **Extensions** for cylinder or thumb-turn 45 mm,



- 11.5554 **Extensions** for cylinder or thumb-turn 80 mm,



- 11.5555 **Extensions** for cylinder or thumb-turn 125 mm,



- 11.508 **Key blanks, each, Silver nickel**
for Trioving keyway #11.520,

