

# IZERWAREN



## Marine Locks and Trim Sets For Swinging and Sliding Doors For Weather Doors and Interior Doors



Edition 25

Non Corrosive Fine Building and Ships Hardware  
IZERWAREN.COM



Stainless steel levers for full size mortise marine locks Finish: satin or mirror polished stainless steel

Izerwaren  
Order  
Numbers

12.527.308 Lever Classic; 135 mm long  
Polished stainless steel

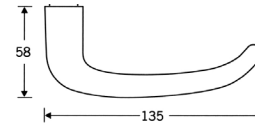

Lever Classic # 12.527; 135 mm long; stands off 58 mm  
Rose #12.110; 55 mm diameter

12.045.308 Lever U shape; 131 mm long  
Polished stainless steel

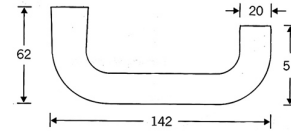

Lever #12.045; 142 mm long; stands off 64 mm; 20 mm diameter

12.547.308 Lever L shape; 132 mm long  
Round corner  
Polished stainless steel

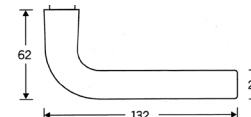

Lever #12.547; 132 mm long; stands off 64 mm; 20 mm diameter

12.576.308 Lever L shape; 132 mm long  
Square corner

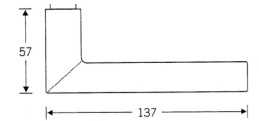

Lever #12.576; 137 mm long; stands off 57 mm; 20 mm diameter

11.363.308 Lever cropped 108 x 49 mm  
Polished chrome plated brass

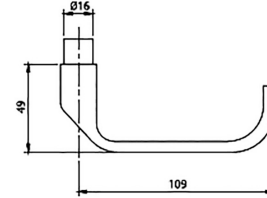

Lever #11.3631; 108 mm long; stands off 49 mm; 20 mm diameter on base

12.53F.308 Lever Semi Flush; 143 mm long  
Polished stainless steel

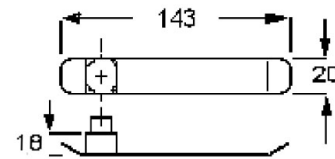

Lever #12.53F; 143 mm long; stands off 25 mm with standard plate; 20 mm wide

12.555.308 Lever Semi Flush; 120 mm long  
Polished stainless steel

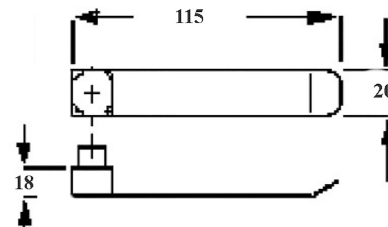

Lever #12.555; 120 mm long; stands off 25 mm; 20 mm wide; Rounded front

12.5SF Lever Semi Flush; 95 mm long  
Polished stainless steel

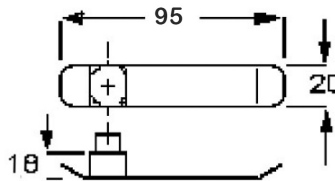

12.329.308 Thumb-turn 30 x 10 mm  
On rose #12.1005 flat  
Polished stainless steel



Lever #12.5SF; 95 mm long; stands off 25 mm with standard plate; 20 mm wide  
Use Lever Handles with Roses or Escutcheon Plates; See page 1-2 for details



**Stainless steel Roses for full size mortise marine locks**  
**Finish: satin or mirror polished stainless steel with Roses and Escutcheons**

→ | 2 3/16" (55) | ←

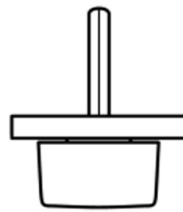

↓  
1 5/32"  
(29)  
↑

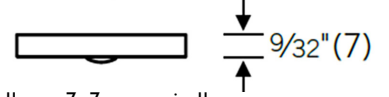
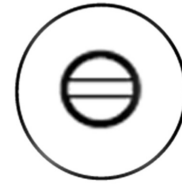

↓  
9/32" (7)  
↑

#12.329.508 thumb-turn / indicator with 55 mm roses. Polished stainless steel available with 8x8 mm spindle or 7x7 mm spindle



← 55 →

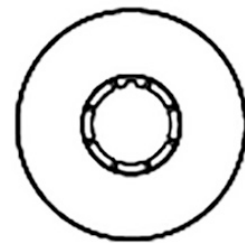

#12.110F.308 Universal rose with inner plastic rose 55 mm diameter. Roses accept all levers and knobs with an 18 mm diameter collar.

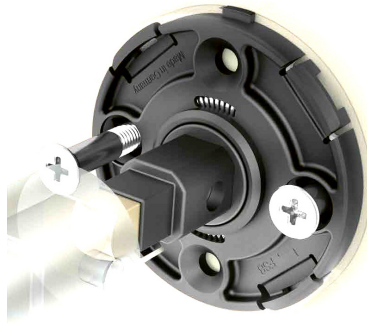

→ | ← 9/32" (7) | ← 55 → |

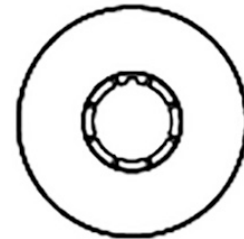
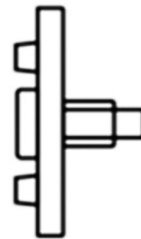

#12.110N.308 Spring loaded rose 55 mm diameter for use with matching levers and 8x8 mm spindle

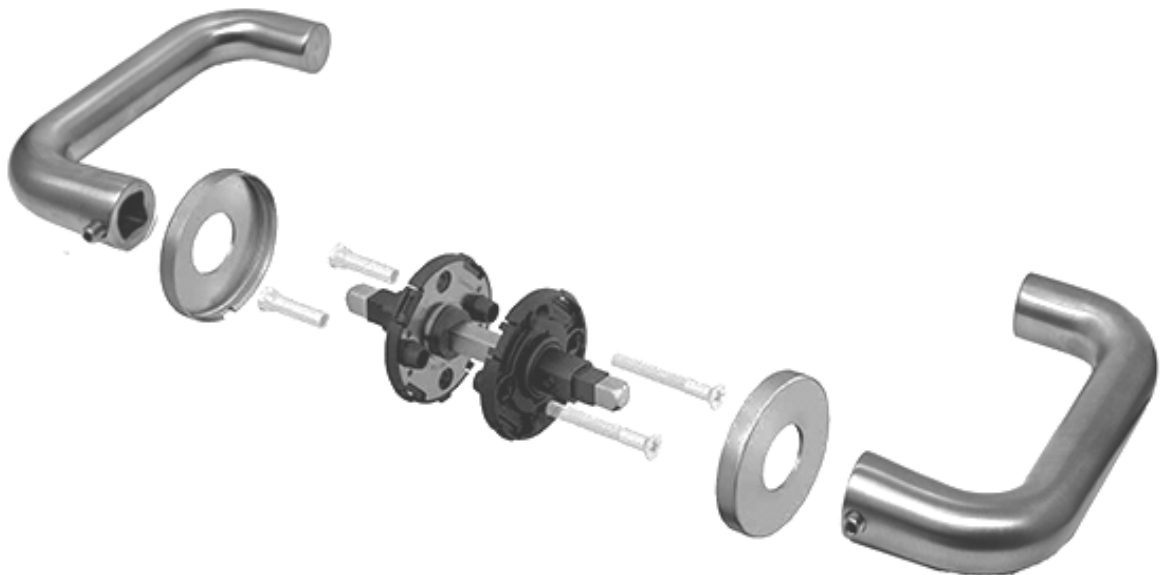

Exploded view of sample of assembly spring loaded roses #12.110N.308 with our matching levers with 8x8 mm stainless steel spindle. Depicted here with lever #12.045



Stainless steel roses for full size mortise marine locks Finish: satin or mirror polished stainless steel



Rose #12.110S Fire rated rose 55 mm diameter with stainless steel inner rose and collar. For use with 9x9 mm stainless steel spindle and stainless steel lever. Shown here with lever #12.045

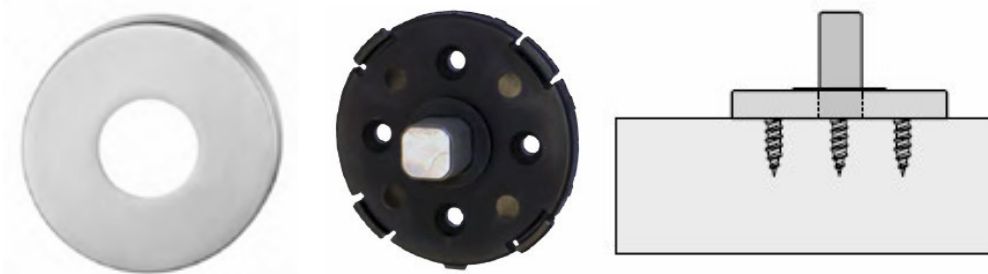

Rose #12.42313.308 Rose 55 mm diameter for use with creating dummy sets, fitting only our matching levers or knobs.

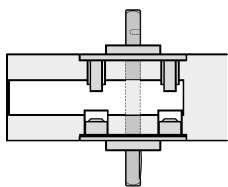

Rose #12.42311 tubular dummy plate with face plate (not shown) use with any lever with 18 mm diameter collar  
Drill hole 18 mm diameter for 8 x 8 mm spindle

**All our levers can be ordered with 19 mm collar or suitable for spring loaded roses for use with 9x9 mm or 8x8 mm spindle**



**Stainless steel escutcheons for full size mortise marine locks**  
**Finish: satin or mirror polished stainless steel**

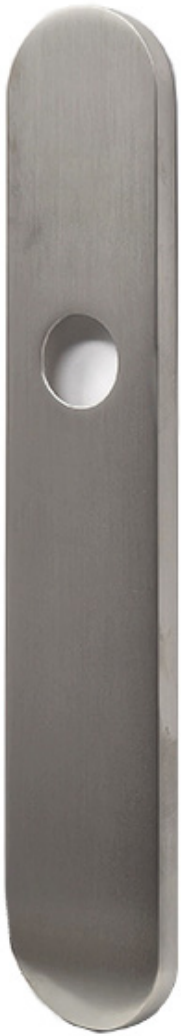

#12.222 Escutcheon stainless steel clip on model

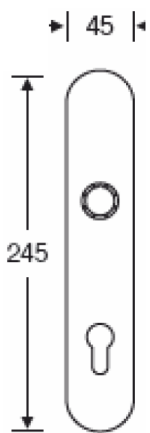

#12.1410 escutcheon Stainless steel clip on model

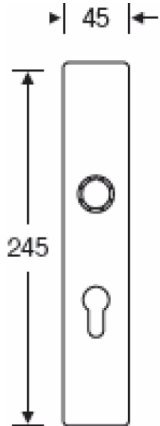

inner spring loaded escutcheon for Izerwaren levers (see page 1-1-3)

**Order only with part #12.222 or part #12.1410**



Inner escutcheon for any lever or knob with 18 mm diameter

**Order only with part #12.222 or part #12.1410**



#12.42314 dummy plate escutcheon for Izerwaren levers (see page 1-1-3)

**Order only with part #12.222 or #12.1410**



**Stainless steel Levers in combination with roses for full size mortise marine locks  
Finish: satin or mirror polished stainless steel**

**1**



Order lever as usual and use for rose part # 12.110F

**UNIVERSAL** set up fits all applications with 9x9 mm or 8x8 mm spindle



**2**

Specify Lever as usual with part number for rose #12.110S



**FIRE RATED** set up Using brass metal insert in lever and stainless steel inner and outer rose with 9x9 mm spindle specify reduction bushing to 8x8 mm spindle



**3**



Specify lever as usual use for rose part# 12.110N

**STANDARD** set up with Stainless steel lever and springloaded plastic inner rose for 8 x8 mm spindle and clip on stainless steel outer rose



**4**

WHEN A LEVER MODEL IS ORDERED

**SEPARATELY**  
WE WILL SHIP AS FOLLOWS:  
WITH INSERT 9X9 MM HOLE  
AND WITH REDUCTION BUSHING TO 8X8 MM HOLE

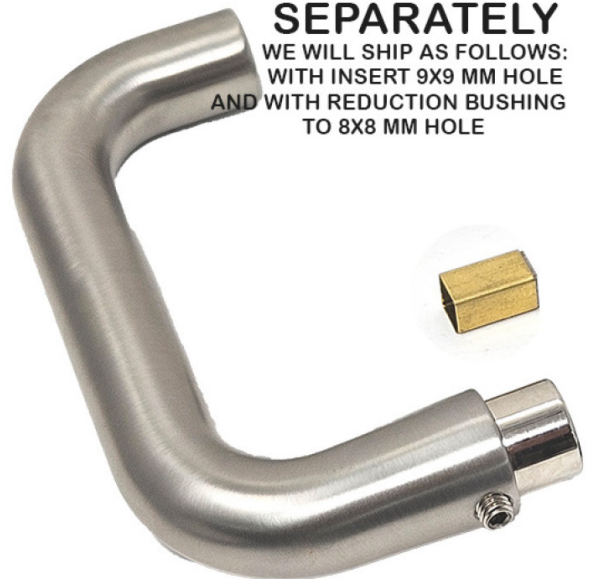



# 11.SEFT.011 Trioving Entry lock with Izerwaren Trimset. Escutcheon #12.222, lever #12.527



#11.SEFT.011 GSV 65 mm backset with Izerwaren Trim





# 19.83Z50.308 Entry Mortise Lock 50 mm Backset for Framed Doors



**#19.82Z25.508 Entry Mortise Lock 25 mm Backset for Framed Doors. Satin Stainless Steel**

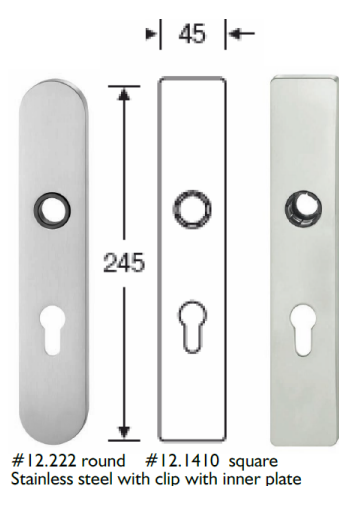
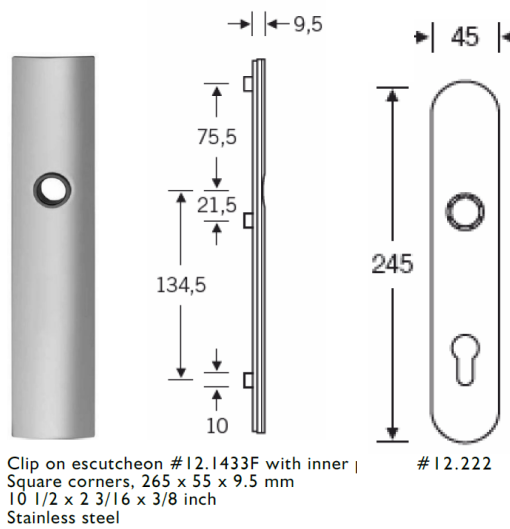
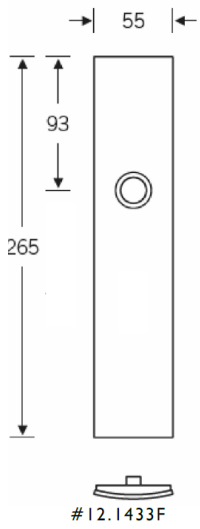

Clip on escutcheon #12.1433F with inner plate  
Square corners, 265 x 55 x 9.5 mm  
10 1/2 x 2 3/16 x 3/8 inch  
Stainless steel